

TOP FIX 90 DEGREE PLATE

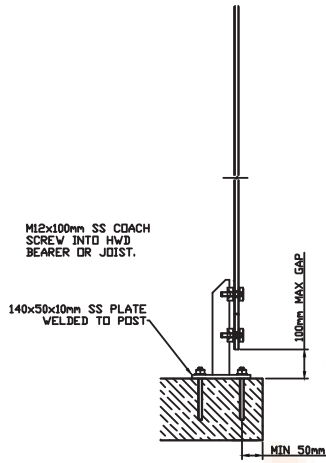

TOP FIX INLINE PLATE

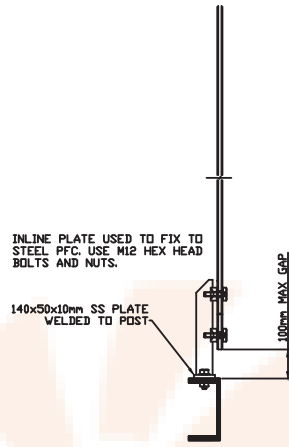

SIDE FIX TIMBER BEARER WITH FC AND TILE

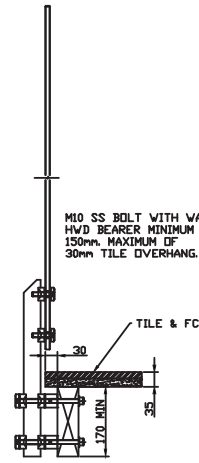

SIDE FIX TIMBER BEARER WITH SHOT EDGE DECKING

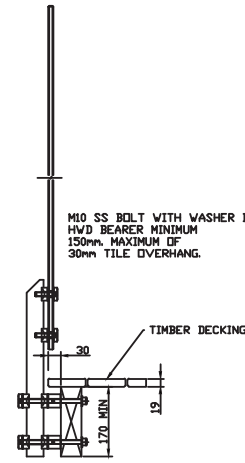

SIDE FIX PFC

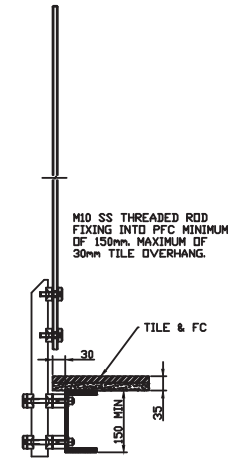

SIDE FIX CONCRETE SLAB

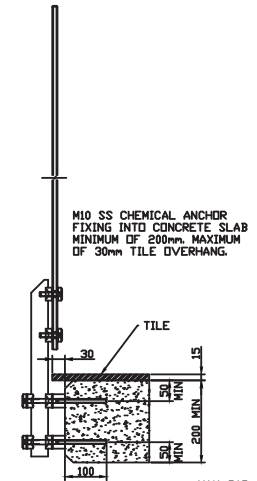

CORE DRILL FIXING

CORE DRILLED HOLE WITH POST FIXED WITH NON SHRINK GROUT. FILL GROUT TO UNDERSIDE OF TILE ONLY & FIX POST RING WITH SIKA II-FC TO STOP WATER EGRESS AND TO AVOID CRACKING TILES THRU EXPANSION OF POST.

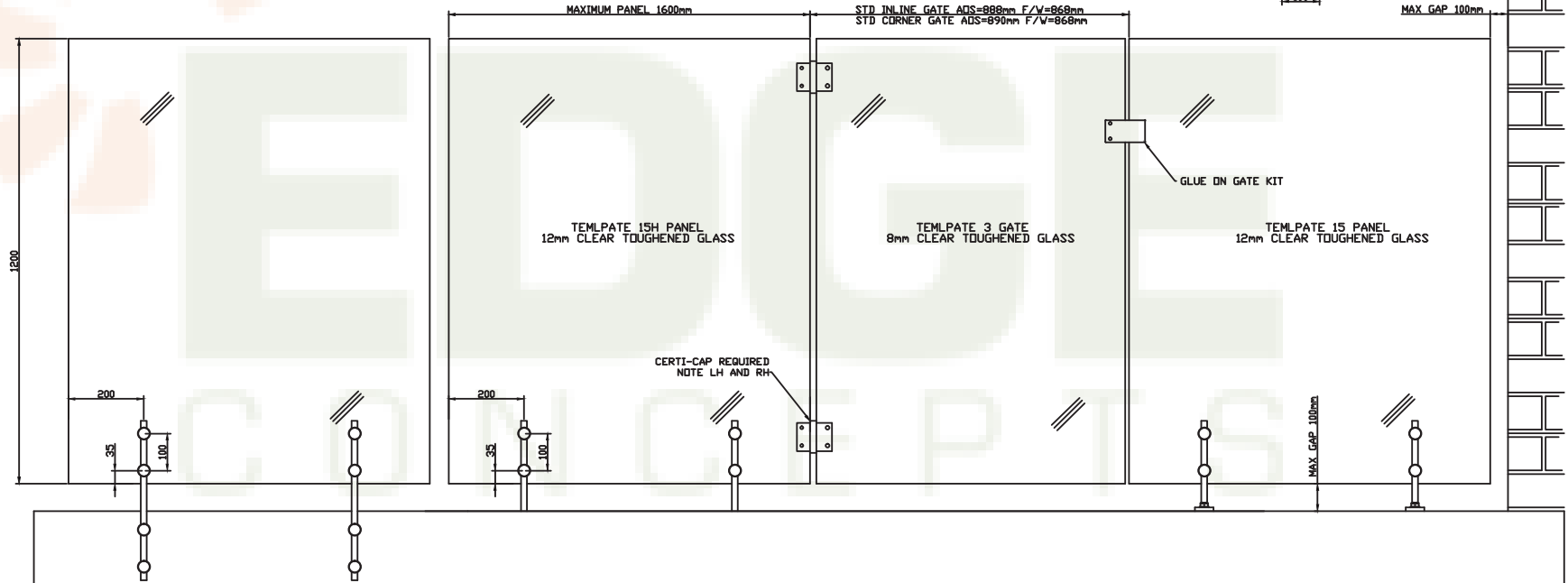

IMPORTED GLASS TEMP 15	
GLASS WIDTH	GLASS HT
1000	1200
1100	1200
1200	1200
1300	1200
1350	1200
1400	1200
1450	1200
1500	1200
1600	1200

IMPORTED GLASS TEMP 15H	
GLASS WIDTH	GLASS HT
1000	1200
1100	1200
1200	1200
1400	1200
1500	1200
1600	1200

NOTES: GATES ALWAYS OPEN AWAY FROM THE POOL.
 *CERTI CAPS ARE TO BE INSTALLED ON THE BOTTOM HINGE NOTE LH AND RH.
 †SUITABLE FOR EDGE PROTECTION OF LESS 1000mm ONLY.

EDGE CONCEPTS (QLD) PTY LTD 50-52 KABI CIRCUIT DECEPTION BAY 4508 PH.3897 8700 FAX.3897 8777	PART NO. D12 MINI POST GLASS FENCING	
	DESCRIPTION EDGE SERIES 1000	
SCALE: NTS	DATE: JAN 2012	DRAWN: A.H.S.